



# MASTER LEDspot LV

## MAS LEDspotLV D 8-50W 830 MR16 36D

Delivering intense accent beam, MASTER LEDspot LV is an ideal retrofit solution for spot lighting. MASTER LEDspot LV is designed to replace halogen or incandescent spots. It realizes natural colors, enables cozy and comfortable ambience for residential, hospitality and emphasizes the beauty of merchandise in retail. New smaller housing provides perfect fitting with majority of luminaires in a market with a MR16 GU 5.3 holder. It not only employs Philips' patented solution to guarantee the broadest possible compatibility with standard 12V halogen electronic transformers, it also delivers high beam intensity which is equivalent to halogen MR16 spots. The dimming function enables to create the desired atmosphere and it works with broad selection of dimmers. Its high SDCM ensure stricter color consistency, that is maintained over product life. MASTER LEDspot LV delivers huge energy savings and minimizes maintenance cost without any compromise on light quality and lifetime, enabling residential and business owners to achieve a return on their investment within short period time.

### Product data

General Information		Operating and Electrical	
Cap-Base	GU5.3 [GU5.3]	Correlated Color Temperature (Nom)	3000 K
Nominal lifetime	40,000 hour(s)	Luminous Efficacy (rated) (Nom)	77.00 lm/W
Switching Cycle	50,000	Color Consistency	<4
Lighting Technology	LED	Color rendering index (CRI)	80
EU RoHS compliant	Yes	LLMF At End Of Nominal Lifetime (Nom)	70 %
		Luminous Flux in 90° Cone (Rated)	621 lm
Light Technical			
Color Code	830 [CCT of 3000K]	Line Frequency	- Hz
Beam Angle (Nom)	36 degree(s)	Input Frequency	- Hz
Luminous Flux	621 lm	Power Consumption	8 W
Luminous Intensity (Nom)	1,700 cd	Lamp Current (Nom)	960 mA
Color Designation	White (WH)	Wattage Equivalent	50 W

# MASTER LEDspot LV

Starting Time (Nom)	0.5 s
Warm-up time to 60% light	0.5 s
Power Factor (Fraction)	0.7
Voltage (Nom)	12 V

## Temperature

T-Case Maximum (Nom)	100 °C
----------------------	--------

## Controls and Dimming

Dimmable	Yes
----------	-----

## Mechanical and Housing

Bulb Shape	MR16 [2inch/50mm]
------------	-------------------

## Approval and Application

Suitable For Accent Lighting	Yes
------------------------------	-----

Energy Consumption kWh/1000 h	9 kWh
EyeComfort	Yes

## Product Data

Order product name	MAS LEDspotLV D 8-50W 830 MR16 36D
Full product name	MAS LEDspotLV D 8-50W 830 MR16 36D
Full product code	871869681269300
Order code	929001881702
Material Nr. (12NC)	929001881702
Numerator - Quantity Per Pack	1
EAN/UPC - Product/Case	8718696812693
Numerator - Packs per outer box	10
EAN/UPC - Case	8718696812709

## Dimensional drawing

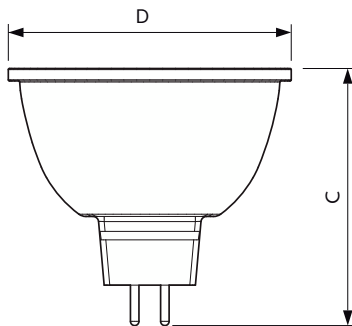

Product	D	C
MAS LEDspotLV D 8-50W 830 MR16 36D	50.5 mm	46.5 mm

## Photometric data

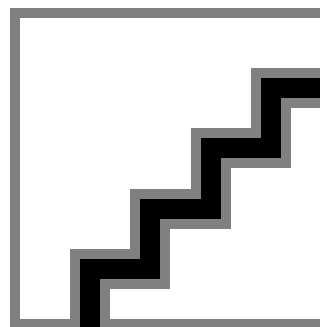
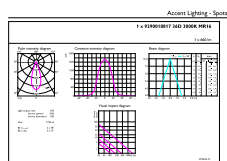

Accent Lighting Spots - MAS LEDspotLV D 8-50W 830 MR16 36D

Spectral Power Distribution Colour - MAS LEDspotLV D 8-50W 830 MR16 36D

# MASTER LEDspot LV

## Photometric data

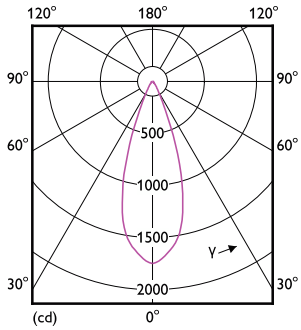

Light Distribution Diagram - MAS LEDspotLV D 8-50W 830 MR16 36D

## Lifetime

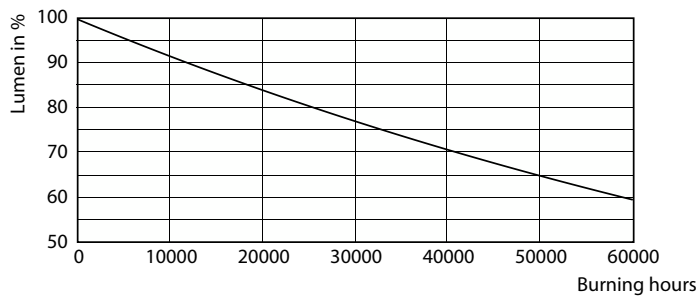

Lumen Maintenance Diagram - MAS LEDspotLV D 8-50W 830 MR16 36D

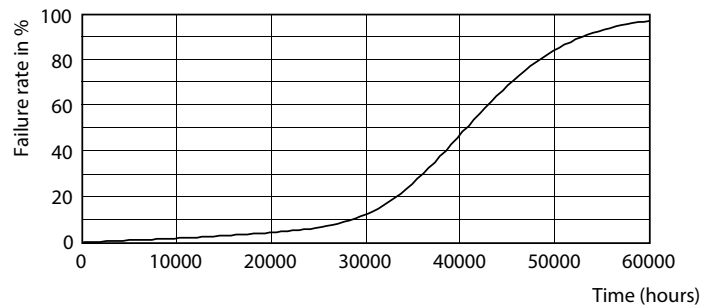

Life Expectancy Diagram - MAS LEDspotLV D 8-50W 830 MR16 36D

