



MASTER LEDspot ExpertColor AR111



MAS LEDspotLV D 20-100W 940 AR111 45D

MASTER LEDspot LV ExpertColor creates a warm and comfortable ambience for hospitality venues, homes and restaurants. It creates such an ambience with superior lighting that has a customized spectrum, high CRI, and deep dimming feature. The result? A beautiful lighting experience. What's more, the innovative, trimless lens design will suit almost any interior decor with its clean and neat look. In addition, you can take advantage of the full ExpertColor family, which also includes LEDspot MV and LEDspot Par lamps.

Product data

General Information		Luminous Flux in 90° Cone (Rated)	1,270 lumen
Cap-Base	G53 [G53]	Operating and Electrical	
Nominal lifetime	25,000 hour(s)	Line Frequency	50 to 60 Hz
Switching Cycle	50,000	Input Frequency	50 to 60 Hz
Lighting Technology	LED	Power Consumption	20 W
Flux measurement reference	Narrow Cone	Lamp Current (Nom)	2,000 mA
Light Technical		Wattage Equivalent	100 W
Color Code	940 [CCT of 4000K]	Starting Time (Nom)	0.5 s
Beam Angle (Nom)	45 degree(s)	Warm-up time to 60% light	0.5 s
Luminous Flux	1,270 lumen	Power Factor (Fraction)	0.7
Luminous Intensity (Nom)	2,300 cd	Voltage (Nom)	ac electronic 12 V
Color Designation	Cool White (CW)	Temperature	
Correlated Color Temperature (Nom)	4000 K	T-Case Maximum (Nom)	97 °C
Luminous Efficacy (rated) (Nom)	63.00 lm/W		
Color Consistency	<4		
Color rendering index (CRI)	91		
LLMF At End Of Nominal Lifetime (Nom)	70 %		

MASTER LEDspot ExpertColor AR111

Controls and Dimming

Dimmable	Only with specific dimmers
----------	----------------------------

Mechanical and Housing

Bulb Finish	Clear
Bulb Shape	AR111

Approval and Application

Energy Efficiency Class	G
Suitable For Accent Lighting	Yes
Energy Consumption kWh/1000 h	20 kWh
EPREL Registration Number	648,248
CE mark	Yes

EU RoHS compliant	Yes
-------------------	-----

Product Data

Full product code	871869970521300
Order product name	MAS LEDspotLV D 20-100W 940 AR111 45D
Order code	929002050802
Numerator - Quantity Per Pack	1
Numerator - Packs per outer box	6
Material number (12NC)	929002050802
Full product name	MAS LEDspotLV D 20-100W 940 AR111 45D
EAN/UPC - Case	8719514275805

Dimensional drawing

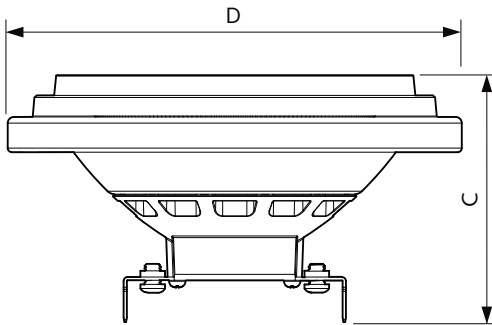

Product	D	C
MAS LEDspotLV D 20-100W 940 AR111 45D	111 mm	62 mm

Photometric data

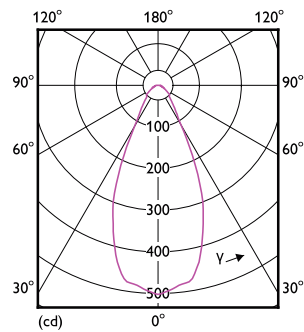
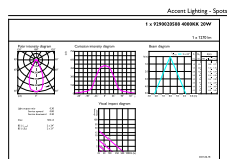

Light Distribution Diagram - MAS LEDspotLV D 20-100W 940 AR111 45D

MASTER LEDspot ExpertColor AR111

Photometric data

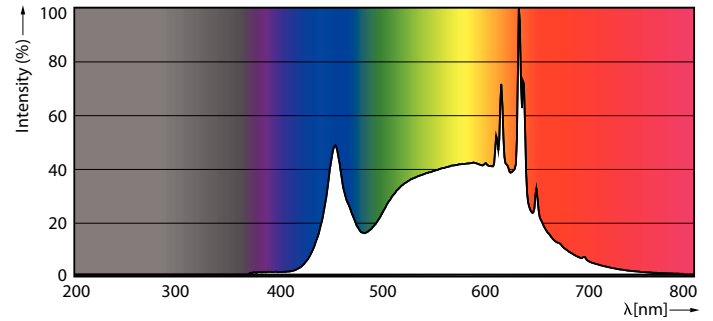
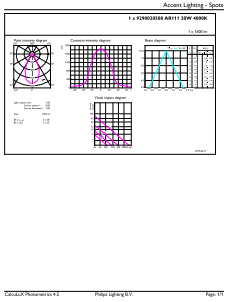

Spectral Power Distribution Colour - MAS LEDspotLV D 20-100W 940 AR111 45D

Lifetime

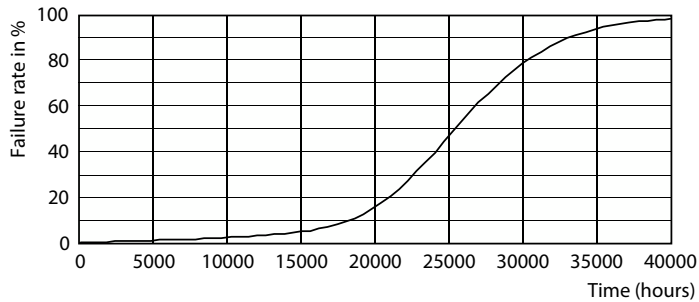

Life Expectancy Diagram - MAS LEDspotLV D 20-100W 940 AR111 45D

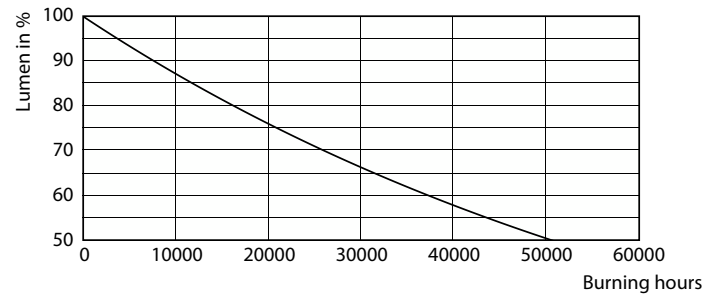

Lumen Maintenance Diagram - MAS LEDspotLV D 20-100W 940 AR111 45D

