

# PRODUCT DATASHEET

## DL UGR19 PFM DN155 14 W 830 WT IP54

DOWNLIGHT UGR19 | Low-glare downlights, suitable for computer screen workstations



### Areas of application

- Suitable for office applications, especially for computer screen workplaces
- Direct replacement for luminaires with compact fluorescent lamps
- Entrances / Hallways
- Bathrooms, kitchens and sheltered outdoor areas
- General illumination

### Product benefits

- Good glare reduction (UGR < 19) and cut off angle up to 30° for comfortable indoor lighting
- Easy and quick installation thanks to connector box with 5-pole toolless terminal
- Low flicker light
- Suitable for use in dusty and damp locations thanks to high IP rating
- 5 years guarantee

### Product features

- Housing material: Aluminum mirror-finished reflector
- Type of protection: IP54 (room side) / IP20 (back side)
- Connector box with push wire terminal for tool-free connection
- Through-wiring possible
- Luminaire versions with IoT-ready DALI-2 driver or IoT Zigbee 3.0 technology available



## TECHNICAL DATA

### Electrical data

Nominal wattage	14.00 W
Nominal voltage	220...240 V
Mains frequency	50...60 Hz
Nominal current	120 mA
Inrush current	20 A
Inrush current time $T_{h50}$	200 $\mu$ s
Max. no. of lum. on circuit break. B16 A	120
Max. no. of lum. on circuit break. C10 A	80
Max. no. of lum. on circuit break. C16 A	120
Power factor $\lambda$	$\geq 0.90$
Total harmonic distortion	< 15 %
Protection class	II
Operating mode	External LED driver

### Photometrical data

Luminous flux	1500 lm
Luminous efficacy	105 lm/W
Color temperature	3000 K
Light color (designation)	Warm White
Color rendering index Ra	$\geq 80$
Standard deviation of color matching	$\leq 5$ sdc <sub>m</sub>
Luminous intensity	-
Low flicker	Yes
Flickering metric (Pst LM)	-
Stroboscope effect metric (SVM)	-
Photobiological safety group acc. to EN62778	RG1
Photobiological safety group acc. to EN62471	RG0
Beam angle	65 °
UGR	< 19

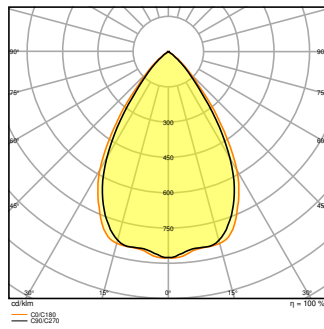
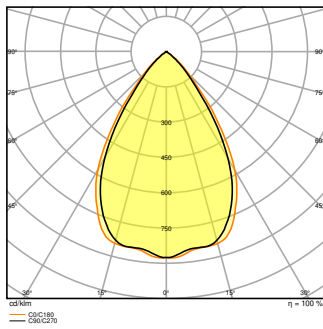
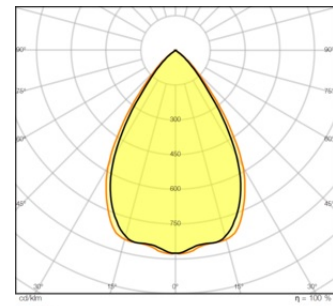
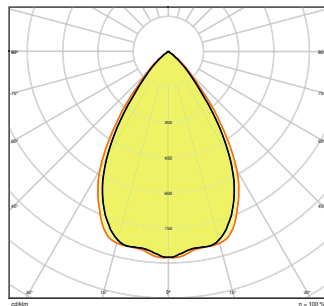
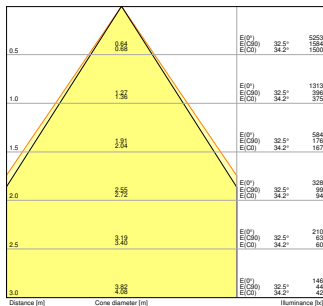
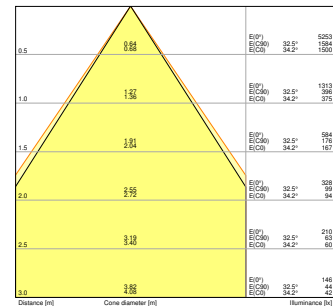
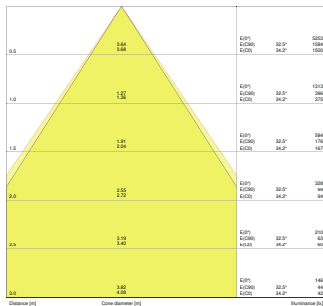

Dimensions & Weight

Diameter	180.00 mm
Height	65.00 mm
Product weight	650.00 g

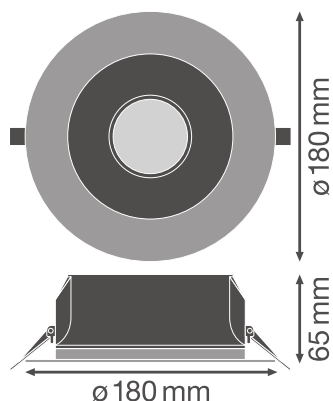

### Materials & Colors

Product color	White
Housing color	White
Body material	Aluminum
Cover material	Polycarbonate (PC)
Light emitting surface material	Polycarbonate (PC)
Glow Wire Test according to IEC 60695-2-12	650 °C
Mercury content	0.0 mg

### Application & Mounting

Ambient temperature range	-20...+45 °C
Temperature range at storage	-40...+70 °C
Type of connection	Screwless terminal
Type of protection	IP54/IP20
Protection class IK (shock resistance)	IK03
Dimmable	No
Mounting type	Recessed
Mounting location	Ceiling
Application environment	Indoor
Mounting diameter	155,0 mm
Mounting depth	100 mm
LED module replaceable	Not replaceable
With light source	Yes

### Lifespan

Lifespan L70/B50 at 25 °C	70000 h
Lifespan L80/B10 at 25 °C	60000 h
Lifespan L90/B10 at 25 °C	40000 h
Number of switching cycles	100000

### Control gear

Output current	450 mA
ECG - Output ripple current	< 10 %
ECG - Length	114.0 mm
ECG - Width	45 mm
ECG - Height	28 mm
Recommended control gear	OSRAM OTI DALI 50/220-240/1A4 NFC

### Certificates & Standards

Standards	CE / CB / ENEC / TÜV SÜD / EAC
Luminaire with limited surface temperature, "D sign"	No
Ball shot safe	No





### Additional product data

Number of illuminants	Not relevant
-----------------------	--------------

### EQUIPMENT / ACCESSORIES

- External control gear included

### DOWNLOAD DATA

DOWNLOAD DATA	
	User instruction
	Addon Technical Information
	Tender documents
	Declarations Of Conformity CE
	IES file (IES)

DOWNLOAD DATA

-  LDT file (Eulumdat)

---

-  R3D file (Relux 3D Model)

---

-  ROLF file (RELUX)

---

-  M3D file (3D Model)

---

-  ULD file (DIALux)

---

-  UGR file (UGR table)

---

-  UGR file (UGR table)

---

-  UGR file (UGR table)

---

-  Packaging insert

LOGISTICAL DATA

Product code	Packaging unit (Pieces/Unit)	Dimensions (length x width x height)	Gross weight	Volume
4058075459137	Folding box 1	215 mm x 84 mm x 219 mm	850.00 g	3.96 dm <sup>3</sup>
4058075459144	Shipping box 24	526 mm x 449 mm x 468 mm	21806.00 g	110.53 dm <sup>3</sup>

The mentioned product code describes the smallest quantity unit which can be ordered. One shipping unit can contain one or more single products. When placing an order, for the quantity please enter single or multiples of a shipping unit.

ADDITIONAL CATALOG INFORMATION

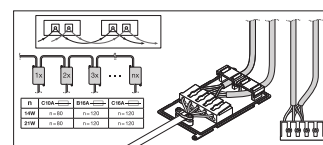
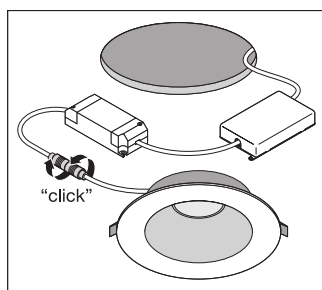
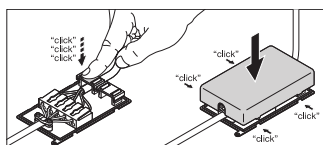

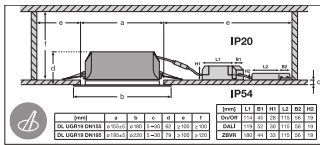

## References / Links

- For Guarantee see [www.ledvance.com/guarantee](http://www.ledvance.com/guarantee)

## DISCLAIMER

Subject to change without notice. Errors and omission excepted. Always make sure to use the most recent release.