



MASTER LEDspot LV

MASTER LEDspotLV D 7-35W WW MR16 36D

Delivering a warm, halogen-like accent beam, MASTER LEDspot LV is an ideal retrofit solution for spot and general lighting applications in the hospitality industry. It is particularly suited to public areas such as receptions, lobbies, corridors, stairwells and washrooms, where the light is on all the time. The robustly designed MASTER LEDspot offers a choice of beam angles for a clearly defined beam spread. There is no UV or IR in the beam, making it suitable for illuminating heat-sensitive objects (food, organic materials, paintings, etc.). Innovative active cooling technology - thanks to the fan inside - results in maximum performance of the lamp. The patented intelligent driver enables broad compatibility with existing electromagnetic and electronic halogen transformers. The dimmable versions drive further efficiencies, while helping to create the desired atmosphere.

Product data

• General Characteristics

Cap-Base	GU5.3
Bulb	MR16 [MR 16inch/50mm]
Rated Lifetime (hours)	40000 hr
Rated Lifetime (years)	25 an

• Light Technical Characteristics

Color Code	WW
Color Designation (text)	Warm White
Beam Angle	36 D
Beam Description	36D [Medium beam]
Correlated Color Temperature	2700 K
Luminous Intensity	1180 cd
Color rendering index	80
Color Temperature	2700 K [CCT 2700K]
Rated Luminous Flux	370 Lm

• Electrical Characteristics

Wattage	7 W
Wattage Technical	7 W
Voltage	12 V
Line Frequency	50-60 Hz
Power Factor	0.8 -
Lamp Current mA	1075 mA

Dimmable	Yes
Wattage Equivalent	35 W
Starting Time	0.5 (max) s

• Measuring Conditions

Switching cycle	50000x
-----------------	--------

• Product Dimensions

Diameter D	50 mm
Overall Length C	54 mm

• Product Data

Order code	929000227302
Full product code	929000227302
Full product name	MASTER LEDspotLV D 7-35W WW MR16 36D
Order product name	MAS LEDspotLV D 7-35W WW MR16 36D
Pieces per pack	1
Packing configuration	10
Packs per outerbox	10
Bar code on pack - EAN1	8718291210450
Bar code on outerbox - EAN3	8718291210467
Logistic code(s) - 12NC	929000227302
Net weight per piece	0.042 kg



PHILIPS

sense and simplicity

Dimensional drawing

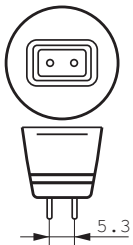
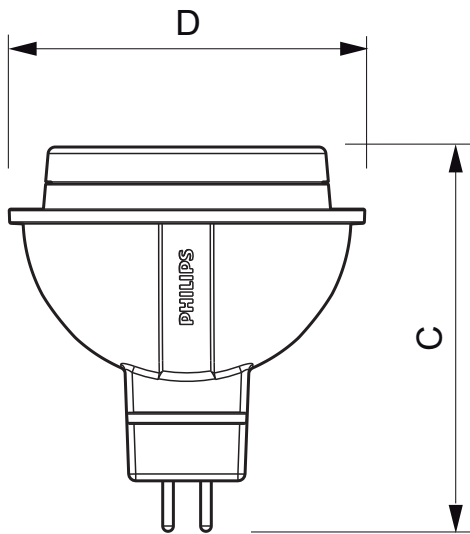

GU5.3

7-35W, 10-50W GU5.3 MR16

Product	C (Norm)	C1 (Max)	D (Norm)	D1 (Norm)
LED D 7-35W WW MR16 36D	54	-	50	-



© 2012 Koninklijke Philips Electronics N.V.
All rights reserved.

Specifications are subject to change without notice. Trademarks are the property of Koninklijke Philips Electronics N.V. or their respective owners.

www.philips.com/lighting

2012, June 19
data subject to change