

PRODUCT DATASHEET

PPRO MR16 35 36° 6.3 W/3000K GU5.3 DIM

PARATHOM PRO MR16 | Dimmable low-voltage LED reflector lamps MR16 with retrofit pin base



AREAS OF APPLICATION

- Shops
- Hospitality
- Museums, art galleries
- Residential interiors
- As a downlight for marking walkways, doors, stairs, etc.
- Spotlighting for accents
- Display cabinets and shop windows
- Spotlighting heat-sensitive objects such as food, plants, etc.
- Outdoor applications only in suitable luminaires

PRODUCT BENEFITS

- Short payback period thanks to low energy consumption and maintenance costs
- Premium light quality thanks to high color rendering index and narrow binning
- Easy replacement of halogen lamps due to compact full glass design and single optic

PRODUCT FEATURES

- Very high color rendering ($R_a : 90$)
- Very high color consistency: ≤ 4 SDCM
- Dimmable (with many common dimmers, see also www.ledvance.com/dim)
- Made in Germany (versions up to 20 W)
- Mercury-free lamps



TECHNICAL DATA

Electrical data

Rated wattage	6.30 W
Nominal wattage	6.30 W
Nominal voltage	12 V
Claimed equiv. conventional lamp power	35 W
Operating frequency	50...60 Hz
Power factor λ	> 0.50

Photometrical data

Nominal luminous flux	350 lm
Rated luminous flux	350 lm
Rated color temperature	3000 K
Lumen main.fact.at end of nom.life time	0.70
Light color (designation)	Warm White
Color temperature	3000 K
Luminous flux	350 lm
Color rendering index Ra	97
Standard deviation of color matching	≤ 3 sdcM
Color rendering index Ra	97
Nominal useful luminous flux 90°	350 lm
Rated useful luminous flux 90°	350 lm
Rated peak intensity	900 cd

Light technical data

Beam angle	36 °
Warm-up time (60 %)	< 0.50 s
Starting time	< 0.5 s
Nominal beam angle	36 °
Rated beam angle (half peak value)	36.00 °

Dimensions & weight

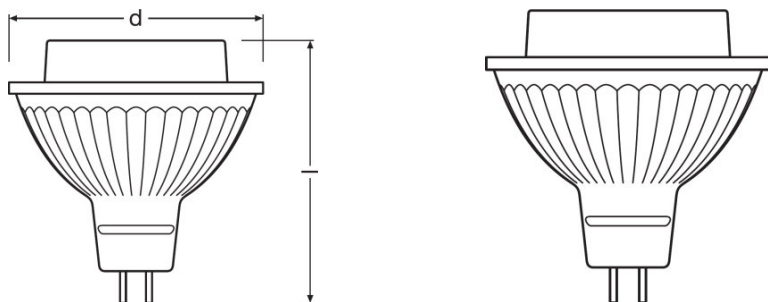

Overall length	53.0 mm
Diameter	51.0 mm
Outer bulb	MR51
Length	53.0 mm
Maximum diameter	51.0 mm

Temperatures & operating conditions

Maximum temperature at tc test point	80 °C
---	-------

Lifespan

Nominal lamp life time	40000 h
Rated lamp life time	40000 h
Number of switching cycles	1000000

Additional product data

Base (standard designation)	GU5.3
Mercury content	0.0 mg
Mercury-free	Yes
Show WEEE picto	Yes
Product remark	All technical parameters apply to the entire lamp/Due to the complex production process for light-emitting diodes, the typical values shown for the technical LED parameters are purely statistical values that do not necessarily match the actual technical parameters of each individual product, which can vary from the typical value

Capabilities

Dimmable	Yes
-----------------	-----

Certificates & standards

Energy efficiency class	A
--------------------------------	---

Energy consumption

7 kWh/1000h

Country-specific categorizations

Order reference

LPMR16D3536 6,3

Light Distribution

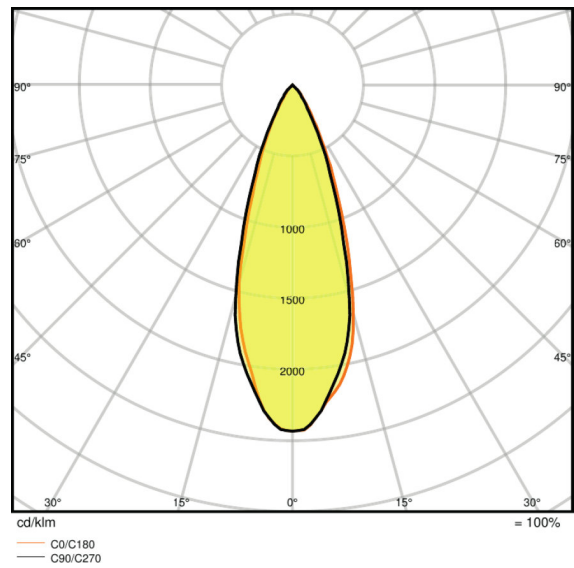
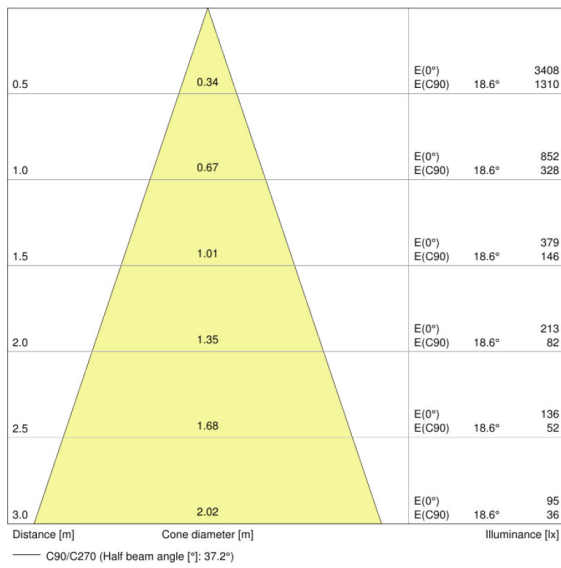

LDC typ cone

LDC typ polar

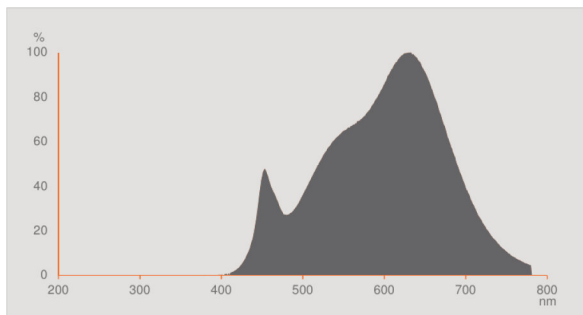

Spectral power distribution

LOGISTICAL DATA

Product code	Packaging unit (Pieces/Unit)	Dimensions (length x width x height)	Gross weight	Volume
4058075094970	Folding carton box 1	49 mm x 49 mm x 62 mm	72.00 g	0.15 dm ³
4058075094987	Shipping carton box 10	255 mm x 107 mm x 72 mm	780.00 g	1.96 dm ³

The mentioned product code describes the smallest quantity unit which can be ordered. One shipping unit can contain one or more single products. When placing an order, for the quantity please enter single or multiples of a shipping unit.

REFERENCES / LINKS

For dimming conformity see

- ▶ www.ledvance.com/dim

For further products and actual information concerning LED lamps see

- ▶ www.ledvance.com/ledlamps

For Guarantee see

- ▶ www.ledvance.com/guarantee

Further information see

- ▶ www.ledvance.com/low-voltage-ledlamps

DISCLAIMER

Subject to change without notice. Errors and omission excepted. Always make sure to use the most recent release.