

# PRODUCT DATASHEET

## O FACADE BELT RD 11 W 3000 K IP54 GY

OUTDOOR FACADE BELT | Luminaires with modern design and light outlet up and down

---

### Areas of application

- Outdoor
- Building facades
- Entrance lighting

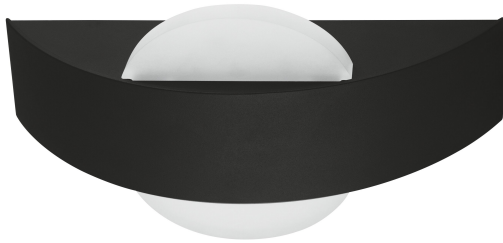

---

### Product benefits

- Energy-efficient thanks to LED technology
- 5 years guarantee
- Easy and quick installation
- Homogeneous light output

---

### Product features

- Bright and functional outdoor LED luminaires
- Type of protection: IP54
- Die-cast aluminum housing
- Available in round and square form
- Diffuser made of opal PMMA



---

**TECHNICAL DATA****Electrical data**

Nominal wattage	11.00 W
Nominal voltage	220...240 V
Mains frequency	50...60 Hz
Nominal current	57 mA
Max. no. of lum. on circuit break. B16 A	75
Max. no. of lum. on circuit break. C10 A	96
Max. no. of lum. on circuit break. C16 A	60
Power factor $\lambda$	> 0.5
Protection class	I
Operating mode	Mains voltage

**Photometrical data**

Luminous flux	400 lm
Luminous efficacy	35 lm/W
Color temperature	3000 K
Light color (designation)	Warm White
Color rendering index Ra	$\geq 80$
Standard deviation of color matching	< 6 sdc <sub>m</sub>
Photobiological safety group acc. to EN62778	RG0
Photobiological safety group acc. to EN62471	RG0
Beam angle	335 °

**Dimensions & Weight**

Length	60.00 mm
Width	240.00 mm
Height	142.00 mm
Product weight	720.00 g

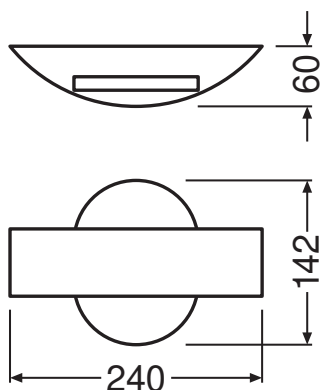

### Materials & Colors

Product color	Gray
Housing color	Gray
Body material	Aluminum
Cover material	Polymethylmethacrylate (PMMA)
Mercury content	0.0 mg

### Application & Mounting

Ambient temperature range	-20...+40 °C
Type of connection	Screw terminal, 3-Pole
Type of protection	IP54
Protection class IK (shock resistance)	IK06
Dimmable	No
Mounting type	Surface
Mounting location	Wall
Application environment	Outdoor
LED module replaceable	Not replaceable

### Lifespan

Lifespan L70/B50 at 25 °C	30000 h
Number of switching cycles	15000

### Certificates & Standards







Standards	CE
Ball shot safe	No

---

## EQUIPMENT / ACCESSORIES

- Complete mounting and connecting accessories included
- 

## DOWNLOAD DATA

DOWNLOAD DATA	
	User instruction
	Declarations Of Conformity CE
	On-Pack-Info
	IES file (IES)
	LDT file (Eulumdat)
	UGR file (UGR table)

---

## LOGISTICAL DATA

Product code	Packaging unit (Pieces/Unit)	Dimensions (length x width x height)	Gross weight	Volume
4058075074972	Folding box 1	90 mm x 287 mm x 208 mm	880.00 g	5.37 dm <sup>3</sup>
4058075074989	Shipping box 6	600 mm x 220 mm x 290 mm	5616.00 g	38.28 dm <sup>3</sup>

---

The mentioned product code describes the smallest quantity unit which can be ordered. One shipping unit can contain one or more single products. When placing an order, for the quantity please enter single or multiples of a shipping unit.

---

## References / Links

- For Guarantee see [www.ledvance.com/guarantee](http://www.ledvance.com/guarantee)
- 

## DISCLAIMER

Subject to change without notice. Errors and omission excepted. Always make sure to use the most recent release.

---