

# PRODUCT DATASHEET

## FL PFM 10 W 3000 K SYM 100 WT

FLOODLIGHT 10 W | Versatile floodlight with up to 1200 lm light output



### Areas of application

- Replacement for floodlights with halogen lamps
- Outdoor use (IP65)
- Public areas
- Building facades
- Construction areas
- Gardens, balconies and other outdoor areas

### Product benefits

- Bright, robust and durable
- Safe and very uniform illumination, due to frosted and tempered glass diffuser
- No upper light output ratio (ULOR 0%) when mounted at 0° tilt
- Energy savings of up to 90 % compared to halogen lamp floodlights
- 5 years guarantee

### Product features

- Reflector-based, symmetric light distribution with 100° x 100° beam angle
- Integrated wide voltage driver, suitable for 100 - 277 V AC
- Surge protection: up to 4 kV (L/N-PE), 2 kV (L-N)
- Mounting bracket with 30° angle and wide rotation area
- Pre-installed, flexible 1 m cable (H05RN-F), wrapped 3 x 1.0 mm<sup>2</sup> single wires



## TECHNICAL DATA

### Electrical data

Nominal wattage	10.00 W
Nominal voltage	100...277 V
Mains frequency	50...60 Hz
Nominal current	49 mA
Inrush current	3.68 A
Inrush current time $T_{h50}$	27 $\mu$ s
Max. no. of lum. on circuit break. B16 A	195
Max. no. of lum. on circuit break. C10 A	142
Max. no. of lum. on circuit break. C16 A	228
Power factor $\lambda$	> 0.90
Total harmonic distortion	< 20 %
Protection class	I
Operating mode	Integrated LED driver

### Photometrical data

Luminous flux	1100 lm
Luminous efficacy	110 lm/W
Color temperature	3000 K
Light color (designation)	Warm White
Color rendering index Ra	$\geq 80$
Standard deviation of color matching	$\leq 5$ sdc <sub>m</sub>
Luminous intensity	-
Flickering metric (Pst LM)	-
Stroboscope effect metric (SVM)	-
Photobiological safety group acc. to EN62778	RG1
Photobiological safety group acc. to EN62471	RG1
Beam angle	100 ° x 100 °

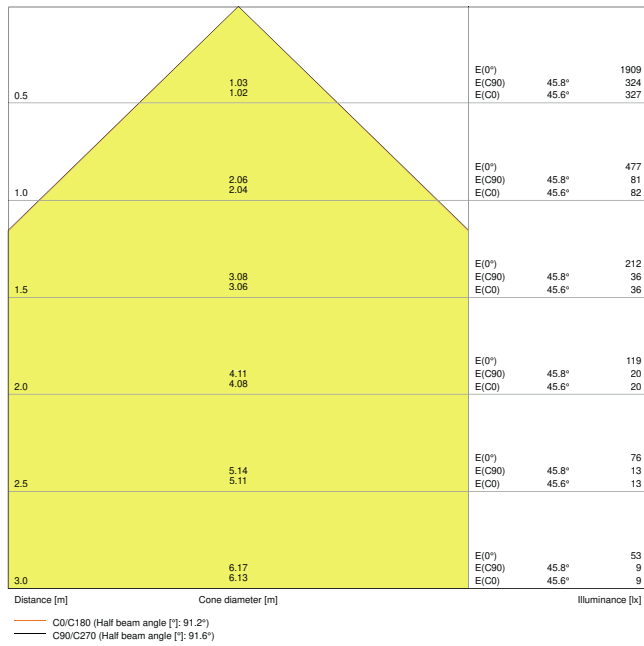

LDC typ cone

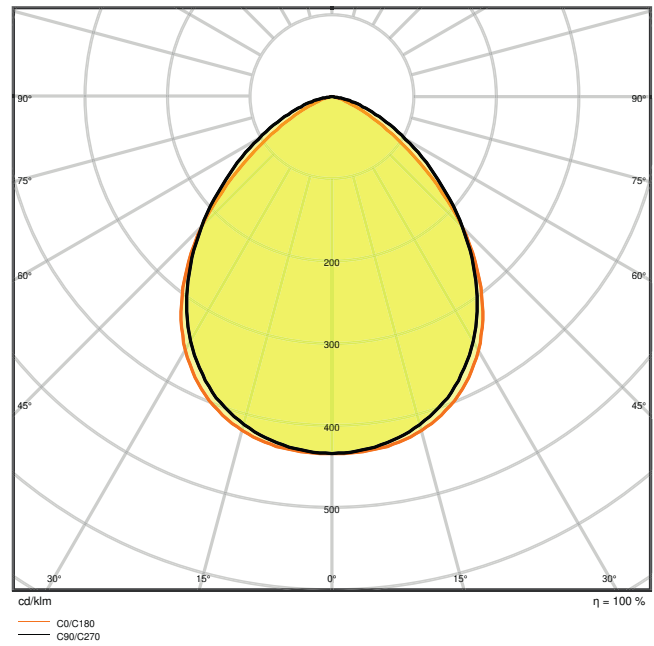

LDC typ polar

### Dimensions & Weight

Length	122.00 mm
Width	131.00 mm
Height	36.00 mm
Product weight	400.00 g
Cable length	1000 mm

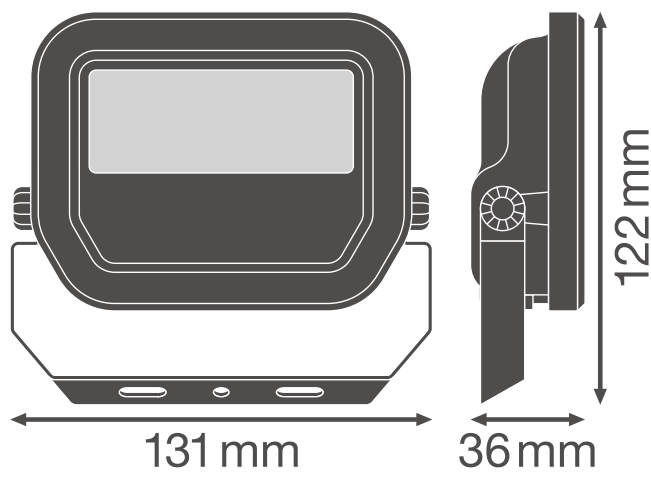

Product line drawing with numbers

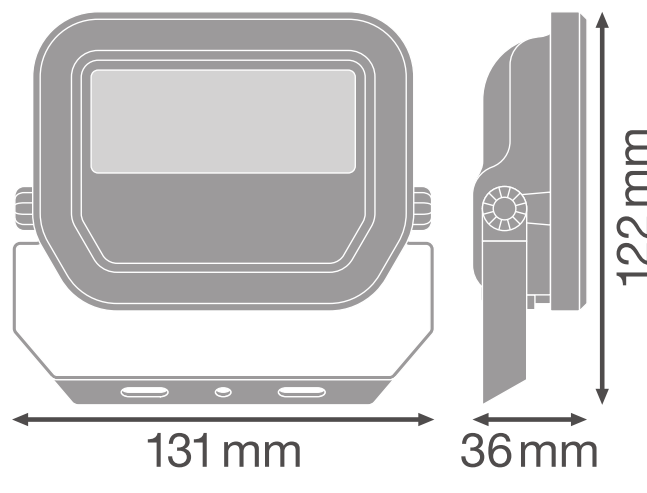

Product line drawing with numbers

### Materials & Colors

Product color	White
Housing color	White
Body material	Aluminum
Light emitting surface material	Glass
Glow Wire Test according to IEC 60695-2-12	650 °C
Mercury content	0.0 mg

### Application & Mounting

Ambient temperature range	-30...+50 °C
Temperature range at storage	-40...+70 °C
Type of connection	Cable, 3-pole
Type of protection	IP65
Protection class IK (shock resistance)	IK07
Dimmable	No
Mounting type	Surface
Mounting location	Wall / Ceiling / Floor
Application environment	Outdoor
Adjustable	Yes
LED module replaceable	Not replaceable

With light source	Yes
-------------------	-----

### Lifespan

Lifespan L70/B50 at 25 °C	70000 h
Lifespan L80/B10 at 25 °C	55000 h
Lifespan L90/B10 at 25 °C	35000 h
Number of switching cycles	100000









### Control gear

Output current	220 mA
ECG - Output ripple current	< 50 %





### Certificates & Standards

Standards	CE / CB / ENEC / EAC / RoHS
Luminaire with limited surface temperature, "D sign"	No
Ball shot safe	No

### DOWNLOAD DATA

DOWNLOAD DATA	
	User instruction
	Addon Technical Information
	Addon Technical Information
	Addon Technical Information
	Tender documents
	Declarations Of Conformity CE
	IES file (IES)
	LDT file (Eulumdat)
	R3D file (Relux 3D Model)

**DOWNLOAD DATA**

	ROLF file (RELUX)
	M4D file (3D Model with rotation axis)
	ULD file (DIALux)
	UGR file (UGR table)
	Packaging insert

**LOGISTICAL DATA**

Product code	Packaging unit (Pieces/Unit)	Dimensions (length x width x height)	Gross weight	Volume
4058075420861	Folding box 1	136 mm x 57 mm x 118 mm	447.00 g	0.91 dm <sup>3</sup>
4058075420878	Shipping box 12	360 mm x 286 mm x 144 mm	5840.00 g	14.83 dm <sup>3</sup>

The mentioned product code describes the smallest quantity unit which can be ordered. One shipping unit can contain one or more single products. When placing an order, for the quantity please enter single or multiples of a shipping unit.

**ADDITIONAL CATALOG INFORMATION**

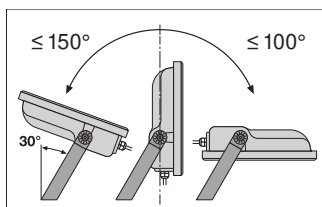

	A	B	C	Key	Weight
10 W	38	60	5.5	2x M4	0.014kg
20 W	38	80	6.5	2x M5	0.018kg
30 W	38	90	6.5	2x M5	0.021kg
50 W	70	110	8.5	2x M6	0.028kg

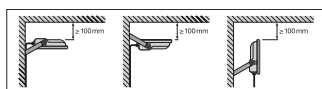
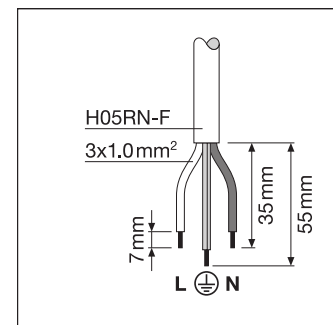

**References / Links**

- For Guarantee see [www.ledvance.com/guarantee](http://www.ledvance.com/guarantee)

**DISCLAIMER**

Subject to change without notice. Errors and omission excepted. Always make sure to use the most recent release.