

PRODUCT DATASHEET

ENDURA Classic Post 80cm E27

ENDURA® CLASSIC POST | Stainless steel luminaires with glass diffuser



Areas of application

- Outdoor use (IP44)
- Building facades
- Entrance lighting
- Patios, balconies
- Pathway lighting
- Driveways

Product benefits

- High flexibility in the choice of the light source thanks to E27 base
- Suitable for smart applications thanks to compatibility with Smart + lamps from LEDVANCE
- Easy and quick installation

Product features

- Stainless steel housing
- Diffuser made of clear glass with hammer finish
- Available with and without motion sensor
- Available as wall and bollard luminaires



TECHNICAL DATA

Electrical data

Nominal voltage	220...240 V
Mains frequency	50...60 Hz
Protection class	I
Operating mode	Mains voltage

Dimensions & Weight

Diameter	800.00 mm
Height	127.00 mm
Product weight	1400.00 g

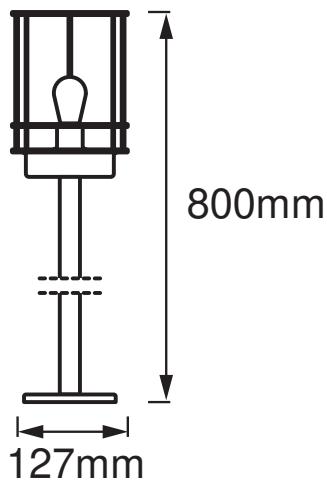

Materials & Colors

Product color	Steel
Housing color	Steel
Body material	Stainless steel
Mercury content	0.0 mg

Application & Mounting

Ambient temperature range	-20...+40 °C
Temperature range at storage	-20...+85 °C
Type of connection	Screw terminal

Type of protection	IP44
Dimmable	No
Mounting type	Standing
Mounting location	Floor
Application environment	Outdoor
With light source	No
Holder designation	E27

Certificates & Standards

Standards	CE / EAC / UKCA
-----------	-----------------



Additional product data

Product remark	Maximum bulb wattage: 60 W
----------------	----------------------------

EQUIPMENT / ACCESSORIES

- Complete mounting and connecting accessories included
- No light sources included

DOWNLOAD DATA

DOWNLOAD DATA	
	User instruction
	Declarations Of Conformity CE
	Packaging insert

LOGISTICAL DATA

Product code	Packaging unit (Pieces/Unit)	Dimensions (length x width x height)	Gross weight	Volume
4058075206588	Folding box 1	154 mm x 154 mm x 826 mm	1470.00 g	19.59 dm ³
4058075206595	Shipping box 4	839 mm x 322 mm x 326 mm	6456.00 g	88.07 dm ³

The mentioned product code describes the smallest quantity unit which can be ordered. One shipping unit can contain one or more single products. When placing an order, for the quantity please enter single or multiples of a shipping unit.

DISCLAIMER

Subject to change without notice. Errors and omission excepted. Always make sure to use the most recent release.