

PRODUCT DATASHEET

FLOODLIGHT 10 W 3000 K IP65 WT

FLOODLIGHT 10 | Floodlight with symmetrical light output with 10 W



Areas of application

- Replacement for floodlights with halogen lamps
- Car parks and underpasses
- Public areas
- Building facades
- Construction areas
- D-sign according to EN 60598-2-24 for fire-risk commercial unit, e.g. by accumulation of dust

Product benefits

- Frosted cover made of tempered glass for uniform illumination
- Optimized weight and size due to compact design
- No upper light output ratio (ULOR 0%) when mounted at 0° tilt
- Energy savings of up to 90 % compared to halogen lamp floodlights
- 3 years guarantee

Product features

- Luminaire efficacy: up to 90 lm/W
- Symmetrical beam angle: 100° x 100°
- Mounting bracket for up to 180° tilting
- Type of protection: IP65
- Impact resistance: IK07
- Ambient temperature in operation: -20...+50 °C
- Connection via 1 m cable, wiring required



TECHNICAL DATA**Electrical data**

Nominal wattage	10.00 W
Nominal voltage	220...240 V
Mains frequency	50...60 Hz
Nominal current	48 mA
Inrush current	11 A
Max. no. of lum. on circuit break. B16 A	125
Max. no. of lum. on circuit break. C10 A	100
Max. no. of lum. on circuit break. C16 A	160
Power factor λ	> 0.90
Total harmonic distortion	< 25 %
Protection class	I
Operating mode	Integrated LED driver

Photometrical data

Luminous flux	1050 lm
Luminous efficacy	105 lm/W
Color temperature	3000 K
Light color (designation)	Warm White
Color rendering index Ra	≥ 80
Standard deviation of color matching	≤ 5 sdc _m
Photobiological safety group acc. to EN62778	RG1
Photobiological safety group acc. to EN62471	RG0
Beam angle	100 ° x 100 °

0.5	1.06 1.08	E(0°) 1891 E(C90) 46.8° 310 E(C0) 47.1° 298
1.0	2.13 2.15	E(0°) 473 E(C90) 46.8° 77 E(C0) 47.1° 75
1.5	3.19 3.23	E(0°) 210 E(C90) 46.8° 34 E(C0) 47.1° 33
2.0	4.26 4.30	E(0°) 118 E(C90) 46.8° 19 E(C0) 47.1° 19
2.5	5.32 5.38	E(0°) 76 E(C90) 46.8° 12 E(C0) 47.1° 12
3.0	6.39 6.46	E(0°) 53 E(C90) 46.8° 9 E(C0) 47.1° 8
Distance [m]	Cone diameter [m]	Illuminance [lx]
— C0/C180 (Half beam angle [°]: 94.2°) — C90/C270 (Half beam angle [°]: 93.6°)		

LDC typ cone

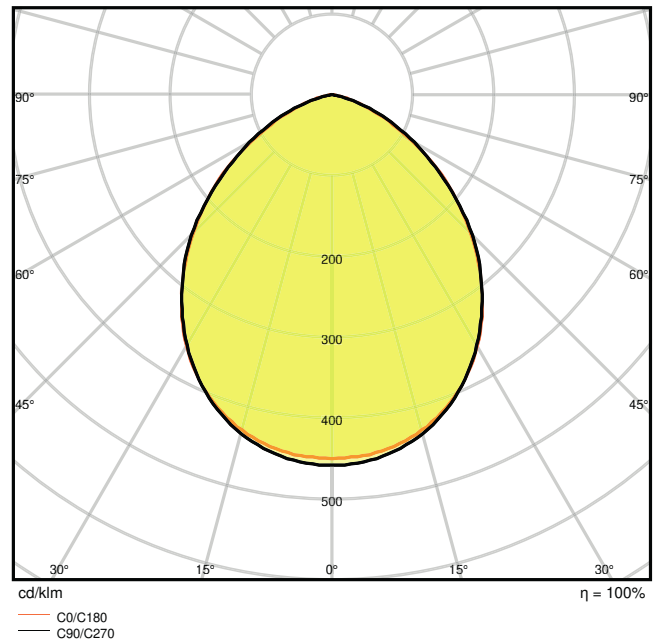

LDC typ polar

Dimensions & Weight

Length	125.00 mm
Width	115.00 mm
Height	39.00 mm
Product weight	380.00 g
Cable length	1000 mm

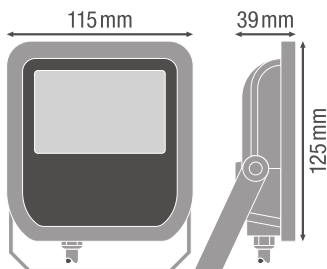

Materials & Colors

Product color	White
Housing color	White
Body material	Polycarbonate (PC)
Cover material	Tempered glass
Light emitting surface material	Glass
Glow Wire Test according to IEC 60695-2-12	650 °C
Mercury content	0.0 mg

Application & Mounting

Ambient temperature range	-20...+50 °C
Type of connection	Cable, 3-pole
Type of protection	IP65
Protection class IK (shock resistance)	IK07
Dimmable	No
Mounting type	Surface
Mounting location	Wall / Ceiling / Floor
Application environment	Outdoor
Adjustable	Yes
LED module replaceable	Not replaceable

Lifespan











Lifespan L70/B50 at 25 °C	50000 h
Lifespan L80/B10 at 25 °C	30000 h
Lifespan L90/B10 at 25 °C	15000 h
Number of switching cycles	100000

Certificates & Standards

Standards	CE / CB / TÜV SÜD / EAC / RoHS
Luminaire with limited surface temperature, "D sign"	Yes
Ball shot safe	No

DOWNLOAD DATA

DOWNLOAD DATA	
	User instruction

DOWNLOAD DATA	
	User instruction
	Certificates
	Declarations Of Conformity CE
	Declarations Of Conformity CE
	On-Pack-Info
	IES file (IES)
	LDT file (Eulumdat)
	R3D file (Relux 3D Model)
	M4D file (3D Model with rotation axis)
	ULD file (DIALux)
	UGR file (UGR table)

LOGISTICAL DATA

Product code	Packaging unit (Pieces/Unit)	Dimensions (length x width x height)	Gross weight	Volume
4058075097384	Folding box 1	46 mm x 124 mm x 192 mm	427.00 g	1.10 dm ³
4058075097391	Shipping box 10	257 mm x 247 mm x 216 mm	5004.00 g	13.71 dm ³

The mentioned product code describes the smallest quantity unit which can be ordered. One shipping unit can contain one or more single products. When placing an order, for the quantity please enter single or multiples of a shipping unit.

ADDITIONAL CATALOG INFORMATION

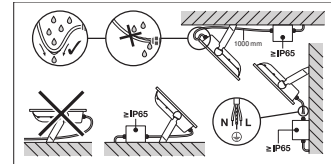
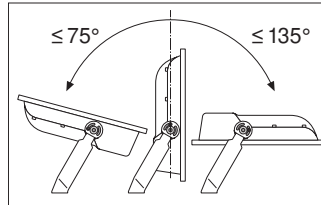
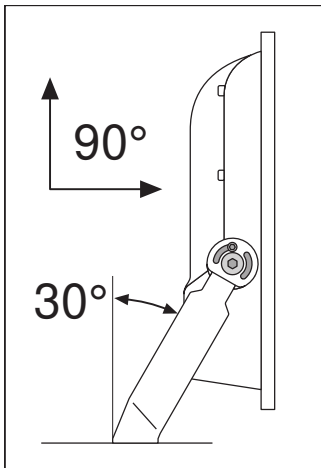

References / Links

– For Guarantee see www.ledvance.com/guarantee

DISCLAIMER

Subject to change without notice. Errors and omission excepted. Always make sure to use the most recent release.